



SCE600TB

Telescopic Boom Crawler Crane 60 Tons Lifting Capacity

Quality Changes the World



The parameters, pictures and standard/optional equipment are only for reference in this brochure, the actual machine is based on the effective price list and contract.



Telescopic Boom Crawler Crane
SCE600TB

P03

Main characteristics

- Lowerworks
- Upperworks
- Product Specification
- Safety Device

P08

Technical parameters

- Main Performance and Parameters
- Basic Dimension of Whole Machine
- Transportation Dimension
- Transportation Scheme

P15

Cofigurations

- Working Range
- Load Chart of H
- Load chart of FJ



SCE600TB
TELESCOPIC BOOM CRAWLER CRANE
60 TONS LIFTING CAPACITY

QUALITY CHANGES THE WORLD

Main Characteristics

- Page 04 Lowerworks
- Page 04 Upperworks
- Page 04 Product Specification
- Page 06 Safety Devices

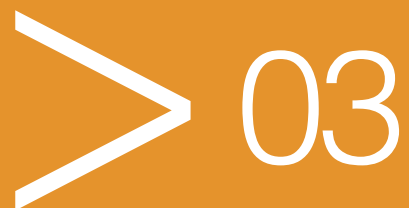

Product Specification



Engine

- Model: CUMMINS B6.7-C225 diesel engine.
- Type: four-stroke, water cooling, straight 6-cylinder, direct injection, turbo supercharging, inter-cooling. Meet Non-road Emission Regulation of Europe (Tier V).
- Displacement: 6.7L.
- Rated power: 168kW/1800rpm.
- Maximum torque: 1186N·m/1300rpm.
- Starting device: 24V-7.8kW.
- Radiator: aluminium sheet fin type radiator core.
- Hand throttle: gear type hand throttle, electric.
- Fuel filter: replaceable paper filter element.
- Battery: 2 12Vx180Ah capacity batteries, connected in series.
- Fuel tank: 400L.

Electrical Control System

- Adopt SYMC integrated control system independently researched and developed by Sany. This system is featured by high integration level, accurate operation and reliable quality.
- Control system: composed of power system, engine system, main control system, Load Moment Limiter, auxiliary system and safety monitoring system. Data communication among controller, display and engine is conducted by CAN bus technology.
- Display: It can display the engine rotating speed, fuel volume, engine oil pressure, servo pressure, engine working time, load weight, boom angle and other working parameters and conditions.

Hydraulic System

- Main pump: adopt open piston pump with large variable displacement, providing oil supply to the main actuator.
- Gear pump: dual-gear pump for swing and control circuit.
- Control: the main pump adopts the control type of electrically proportionate positive flow, and the winch motor is piston motor with variable displacement. The operating components are two hydraulically-controlled cross handles, one hydraulic control pedal valve for boom telescoping, and one dual-gear pedal control valve for travel, to control each actuator proportionally.
- Way of cooling: heat exchanger, fan core and multi-stage cooling.
- Filter: large flow, high accuracy filter, with bypass valve and indicator, which can remind the user to replace the filter element in time.

- Max. pressure of system:
Main/aux. load hoist and travel system: 32MPa;
Boom hoist cylinder lifting: 32MPa;
Swing system: 24MPa;
Control system: 4.5MPa.
- Hydraulic oil tank capacity: 800L.

Main and auxiliary lifting mechanism

- Pump and motor: energy-efficient, combination of winch balance valve and anti-hook-sliding technology, lifting or lowering the load steadily.
- Winch brake adopts wet type and spring loaded fin type normally engaged brake, spring force braking, oil pressure released.
- Main and aux. load hoist winches adopt piston motor of fixed displacement to drive planetary reducer.

Main load hoist mechanism	Rope speed (outermost layer)	0~120m/min
	Diameter of wire rope	Φ18mm
	Overall length of wire rope	240m
	Rated line pull of single rope	5.2t
Auxiliary load hoist mechanism	Rope speed (outermost layer)	0~120m/min
	Diameter of wire rope	Φ18mm
	Overall length of wire rope	135m
	Rated line pull of single rope	5.2t

Boom hoist mechanism

- Double acting single piston rod hydraulic cylinder, fitted with safety balance valve, luffing angle: $-2^{\circ}\sim 78^{\circ}$, adopting dead-weight luffing system to reduce the energy consumption and improve the steadiness of luffing operation.

Swing mechanism

- Swing brake adopts wet type and spring loaded fin type normally engaged brake, spring force braking.
- With integrated cushion valve, the swing system has free slip function to realize steady swing start and control, showing outstanding microinching performance.
- Unique swing cushion design ensures more stable braking.
- Swing drive: external gearing swing drive, capable of conducting 360° rotation, maximum rotation speed 2.2r/min. The maximum driving pressure can reach 24MPa.
- Swing lock: the upperworks can be locked in four positions by cylinder lock.
- Swing bearing: single row ball type bearing.



Product Specification

Counterweight

- Block-type counterweight is easy to assemble and disassemble. The self-assembly function is realized for easier transportation.
- The counterweight tray and blocks are stacked in a way that is easy to assemble, disassemble and transport.
- Rear counterweight: total 19t, with self-assembly function.
- The load charts of lifting without counterweights is available.

Superstructure

- High strength steel welding frame structure, no torsional deformation, reasonable component layout, and convenient maintenance service.

Cab and Control

- Novelty in cab design, artistic modeling and trim and large area glass window with a tilt angle of 20° to broaden horizon; fitted with low beam headlamp and rearview mirror to broaden horizon; installed with air conditioner and radio; the arrangement of seats, control handle and various control buttons is ergonomically designed to enable more conformable operation.
- Large integrated touch screen is adopted and the vibration handle is optionally offered, making the man-machine interaction better.
- Armrest box: operation handle, electrical switch, emergency stop switch and ignition switch are installed on the left and right armrest boxes. The armrest box can be adjusted with the seat.
- Seat: suspension type multi-mode multi-level regulated seat, fitted with unloading switch.
- Air conditioner: cooling and heating air, optimized air passage and air port.
- Multiple cameras can be presented on the monitor at the same time to realize real-time monitoring of wire rope on each winch, conditions behind the counterweight and surrounding the machine.

Traveling drive

- Independent traveling drive device is adopted for each side of crawler frame, so as to realize straight travel, turning through reducer and drive wheel by travel motor. And the machine is capable of automatically pick up the direction of dead ahead.
- Traveling speed: The traveling can be switched between high speed and low speed, and the high speed can be up to 2.2km/h;
- Gradeability: 45%.

Traveling braking

- Concealed wet type and spring loaded fin type normally engaged brake, spring force braking, oil pressure released.

Telescopic crawler

- The extension and retraction of crawler frames are realized through cylinder. The crawlers are extended at work and retracted for transport with the whole basic machine.
- The crawler is allowed fully extended or retracted during work, the respective load charts offered.

Crawler tensioning

- Jack is adopted to push the drive wheel and adjust the tension by adding shims.

Steering system

- It can realize single track turning and pivot turning.

Track shoe

- High strength alloy casting track shoes can stronger grip and ensure longer service life. 800mm wide, 60 pieces x 2.

Track roller

- Maintenance-free track roller.

Product Specification



Main boom

- The boom is made of high-strength steel structure with U-shape section area, with five sections, of which the basic boom is 11.88m and the max. boom length is 46m.
- Dual cylinder full power rope row for telescoping.

Fixed jib

- Two FJ configurations: 9.2m and 16m respectively.
- Installation angle includes 0°, 15° and 30°.

Boom tip pulley

- Welding structure, connected with the boom through pin, and used for auxiliary hook operation.

Lifting hook

Name	Capacity (t)	Pulley block	Weight (t)	Quantity
1	60	6	0.62	1
2	35	3	0.55	1
3	15	1	0.3	1
4	5	1	0.1	1

Safety Device



Smart Integrated Load Moment Indicator

- The integrated LMI system is provided as standard offering to realize calibration-free and high safety and efficiency for equipment control to realize calibration-free and high safety and efficiency for equipment control.
- The LMI system can automatically detect the suspended load weight, working radius of the crane and the angle of boom, and compare rated load weight and actual load, working radius and boom angle. Under normal operation condition, it can intelligently judge and automatically cut off the crane action in dangerous direction, and have black box function to record the overload information.
- Its main components include: monitor, controller, length and angle sensor, pressure sensor, etc.

Assembly/working mode switching switch

- In Assembly Mode, certain safety devices are disabled to facilitate crane assembly.
- In Work Mode, all safety limiting devices activate to protect the operation.

Emergency Stop

- In emergency situation, this button is pressed down to cut off the power supply of the whole machine and all actions stop.

Over-hoist Protection of the Main/Auxiliary Load Hoist

- Height limiter is equipped on the boom/jib tip, which prevents the hook lifting up too much. When the hook is lifted up to the limit height, the limit switch activates, alarm pops up on the monitor, buzzer on the right front control panel sends alarm, failure indicator light starts to flash and the hook hoisting action is cut off automatically.

Over-release Protection of the Main/Auxiliary Load Hoist

- Three-wrap protector is installed on main and aux. load hoist to prevent over-release of wire rope. When the rope is paid out close to the last three wraps, the limit switch acts, and the system sends alarm through buzzer and show the alarm on the monitor, automatically cutting off the winch action.



Safety Device

Function Lock

- If the function lock lever is not in work position, all the other handles won't work, which prevents any mis-operation caused by accidental hitting.

Slewing Lock

- Electrical lock is provided, which needs to be released for swing to work, so as to prevent operator accidentally hit the handle and ensure the safety.
- The slewing lock device can lock the upperworks at two directions.

Hook Latch

- The lifting hook is installed with a baffle plate to prevent wire rope from falling off.

GPS Monitoring System

- Standard remote monitoring system: It can provide functions like GPS locating, GPRS data transfer, machine status inquiry and statistics, operating data monitoring and analysis, and remote diagnosis of failures.

Tri-color Load Indicator

- The load indicator light has three colors, i.e., green, yellow and red; and the real time load status is presented on the display. When the actual load is smaller than 90% of rated load, the green light is on; when the actual load is larger than 90% and smaller than 100%, the yellow light is on, the alarm light flashes and sends out intermittent sirens; when the actual load reaches 100% of rated load, the red light is on, the alarm light flashes and sends out continuous sirens. When the actual load reaches 102%, the system will automatically cut off the crane's dangerous operation.

Flash Alarm

- When the LMI is powered on, the flash alarm will turn on.

Swing Indicator Light

- The swing indicator light flashes during traveling or swing.

Seat Interlock

- If the operator leaves the seat, all control handles and switches will be disabled immediately to prevent any mis-operation due to accidental collision.

Illuminating Light

- The machine is equipped with short-beam light in front of machine, lamps in operator's cab and lighting devices for night operation, as well as boom lights, so as to increase the visibility during work.

Rearview Mirror

- It is installed at the front of the operator's cab and at the right handrail of the platform.

Level Indicator

- Electrical level indicator can show the inclination angle of superstructure on the monitor.

Closed Circuit Monitoring System

- There are two cameras on the tail of rotating bed, which can show the rear part and winches working on the machine.



SCE600TB
TELESCOPIC BOOM CRAWLER CRANE
60 TONS LIFTING CAPACITY

QUALITY CHANGES THE WORLD

Technical Parameters

- Page 09 Major Performance & Specifications
- Page 10 Outline Dimension
- Page 11 Transport Dimension
- Page 13 Transport Plan



Major Performance & Specifications

Major Performance & Specifications of SCE600TB			
Specification		Unit	Parameter
Outline dimension	Full length of the whole crane	mm	14714
	Width of the whole machine (retracted)	mm	4800 (3000)
	Height of the whole machine	mm	3381
	Center distance of driving and engaged wheels	mm	5310
	Width of track shoe	mm	800
H (main boom) configuration	Maximum rated lifting weight	t	60
	Main boom length	m	11.88~46
	Main boom angle	°	-2~78
	Maximum rated lifting moment	t·m	220
FJ(fixed jib) configuration	Longest main boom + longest jib	m	46+16
	Included angle between main boom and jib	°	0, 15, 30
Working speed	Main/aux. load hoist rope speed	m/min	0~120
	Time to fully boom up/down	s	64/80
	Time to fully extend/retract boom	s	85/100
	Slewing speed	rpm	0~2.2
	No-load traveling speed	km/h	0~2.2
Engine	Model	-	CUMMINS B6.7-C225
	Rated power	kW/rpm	168/1800
Wire rope	Diameter	mm	Φ18
Transportation parameters	Weight of the whole machine	t	66.7
	Maximum weight of single piece transportation	t	46.1 (remove counterweight, jib, main and aux hooks)
	Transportation dimension (long x width x height)	mm	14714×3000×3381
Other Parameters	Average ground bearing pressure	MPa	0.095
	Min. swing radius	mm	4405

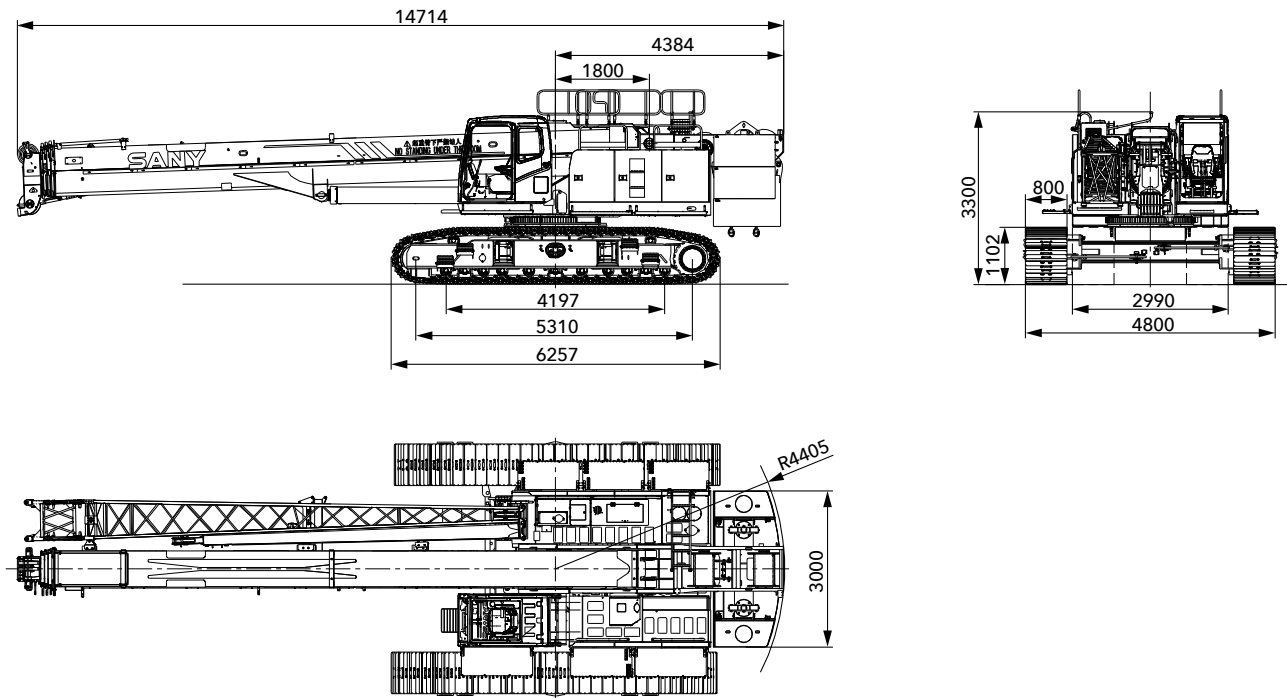
Outline Dimension

Transport Dimension

Note:

- ① . The component transportation dimension is schematic diagram, and is not drawn to scale. The marked dimension is design value, excluding the package.
- ② . The weight is design value, which may be slightly different because of manufacturing tolerance. The total weight of counterweight is 19t.
- ③ . After product upgrading of the Company, the outline dimension and weight of the components above may vary, and the new product shall prevail.

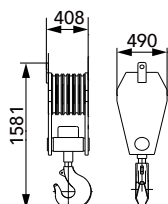
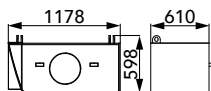
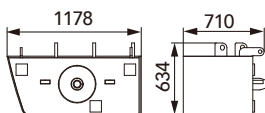
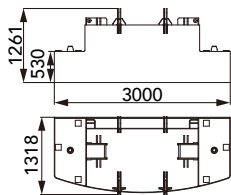
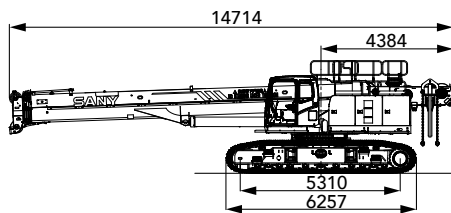
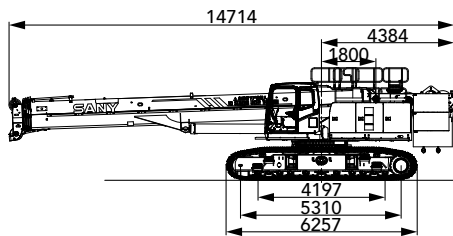

Whole Machine ×1	
Length (L)	14.71m
Width (W)	3.00m
Height (H)	3.38m
Weight	66.7t

Basic Machine (without counterweight, jib and hooks) ×1	
Length (L)	14.71m
Width (W)	3.00m
Height (H)	3.38m
Weight	46.1t

Counterweight Tray ×1	
Length (L)	3.00m
Width (W)	1.32m
Height (H)	1.26m
Weight	12.6t

Rear Counterweight I ×2	
Length (L)	1.18m
Width (W)	0.63m
Height (H)	0.71m
Weight	1.6t

Rear Counterweight II ×2	
Length (L)	1.18m
Width (W)	0.60m
Height (H)	0.61m
Weight	1.6t

60t Hook ×1	
Length (L)	0.41m
Width (W)	0.49m
Height (H)	1.58m
Weight	0.62t

Transport Dimension

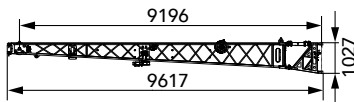
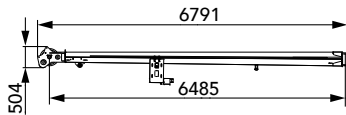
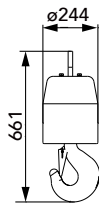
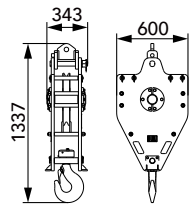
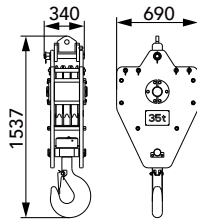

35t Hook

×1

Length (L)	0.36m
Width (W)	0.69m
Height (H)	1.54m
Weight	0.55t

15t Hook

×1

Length (L)	0.33m
Width (W)	0.60m
Height (H)	1.34m
Weight	0.3t

5t Hook

×1

Length (L)	0.24m
Width (W)	0.24m
Height (H)	0.66m
Weight	0.1t

6.5m Jib

×1

Length (L)	6.79m
Width (W)	0.36m
Height (H)	0.50m
Weight	0.24t

9.2m Jib

×1

Length (L)	9.62m
Width (W)	0.80m
Height (H)	1.03m
Weight	0.7t

Transport Plan

- **Transport mode 1: whole machine transport, total weight: 66.7t, L×W×H: 14.71m×3.0m×3.4m.**

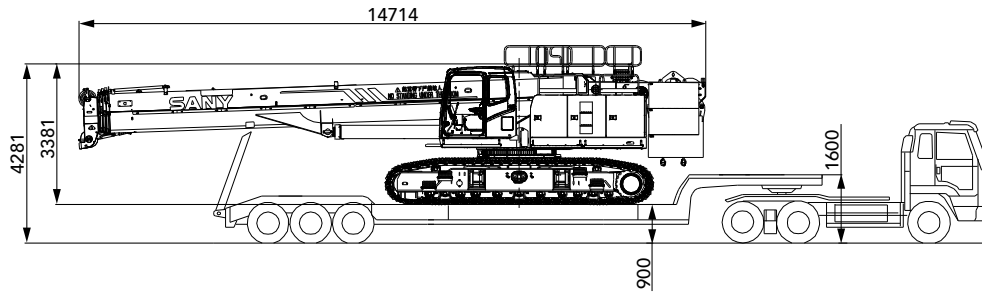

- **Transport mode 2: remove counterweight**

Trailer 1: basic machine, remove counterweight, total weight: 47.7t, L×W×H: 14.71m×3.0m×3.4m.

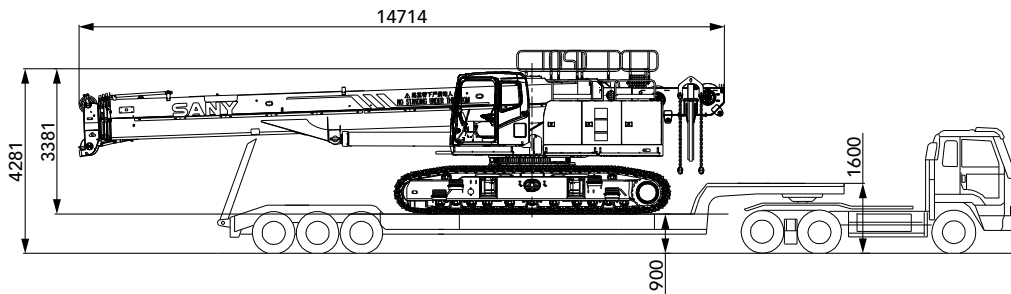

Trailer 2: rear counterweight, weight: 19t.

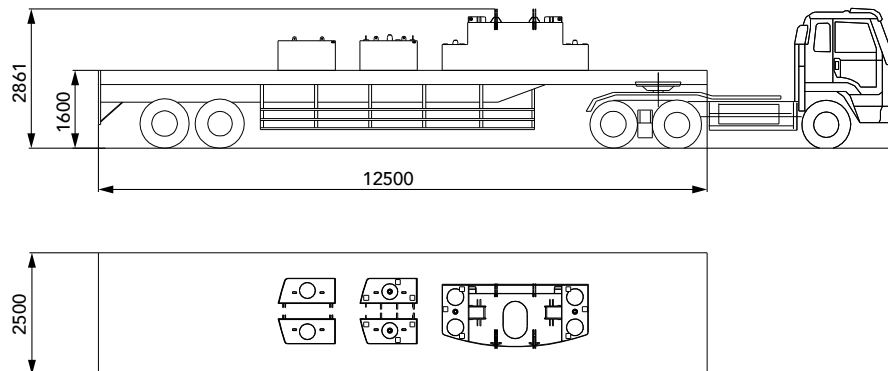

Transport Plan

■ Transport mode 3: remove counterweight, jib, and hooks, by 2 trails.

Trailer 1: basic machine, remove counterweight, hooks and jib, total weight: 46.1t.

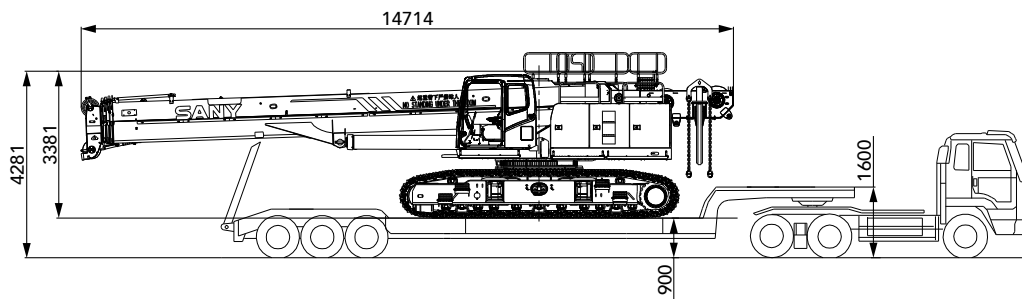

Trailer 2: counterweight, hooks and jib, total weight: 20.6t.

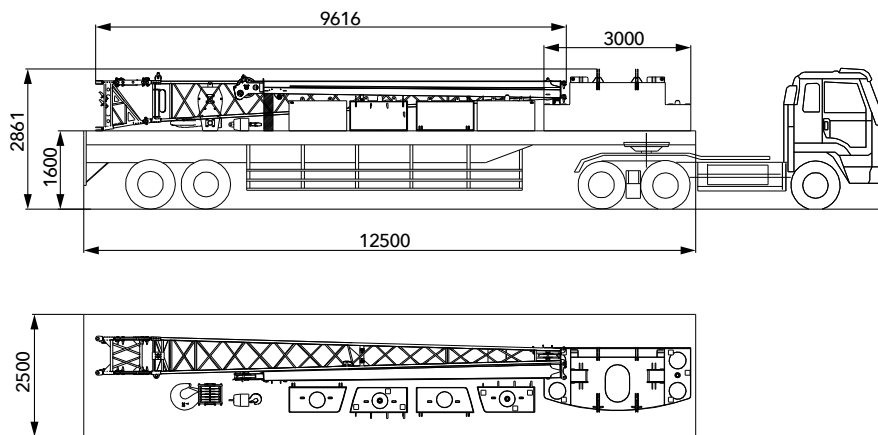



SCE600TB
TELESCOPIC BOOM CRAWLER CRANE
60 TONS LIFTING CAPACITY

QUALITY CHANGES THE WORLD

Cofigurations

- Page 16 Working Range
- Page 17 Load Chart of H
- Page 19 Load chart of FJ

> 15

Working Radius of H Configuration

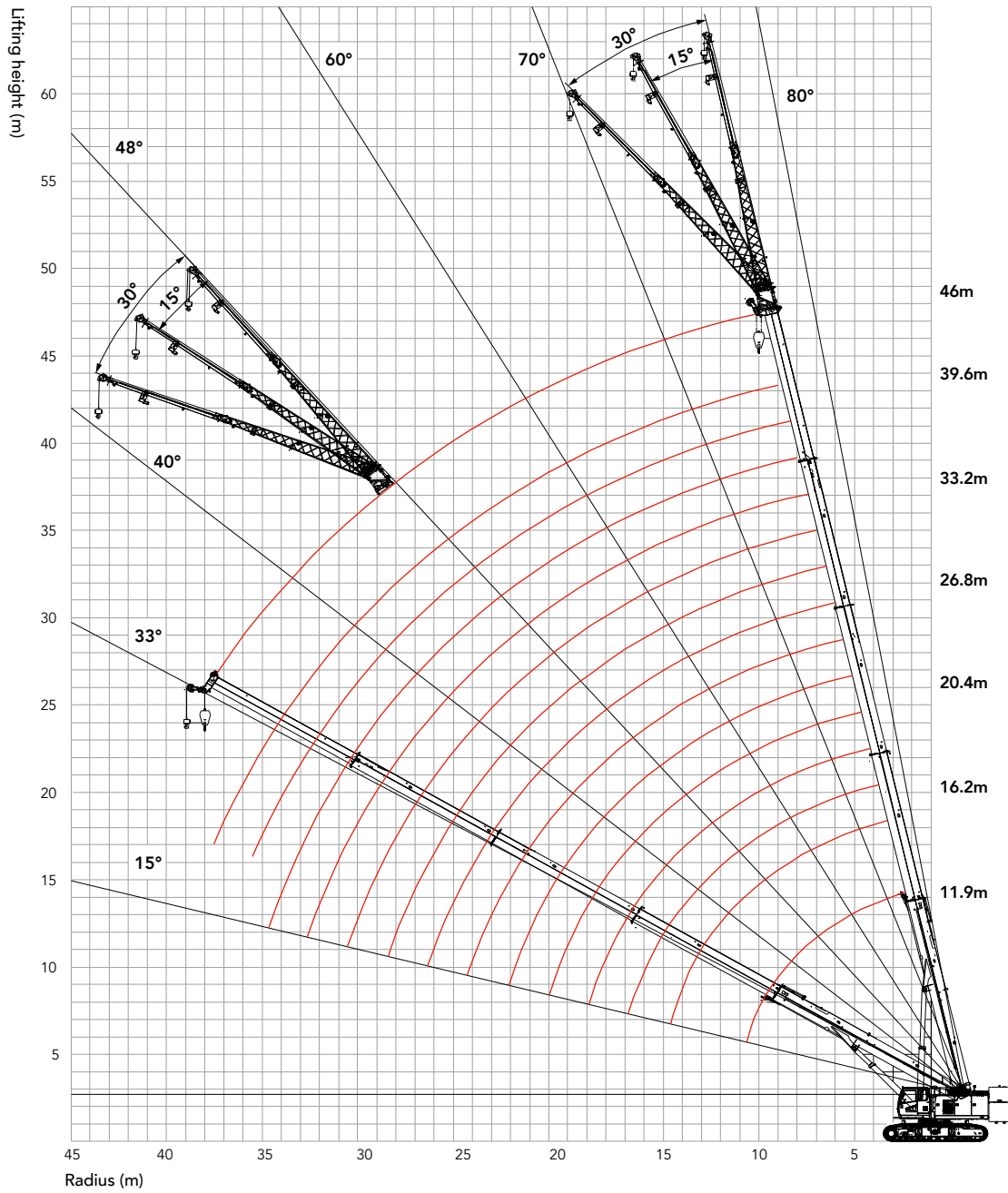

Unit: t

Load chart of H

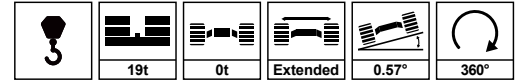

















H Load Chart																
	11.9	16.2	20.4	26.8	33.2	39.6	46.0	18.3	24.7	31.1	37.5	22.5	28.9	35.3	41.7	
3.0	60.0	46.0						28.0								3.0
3.5	51.5	46.0	36.0					28.0								3.5
4.0	48.0	46.0	36.0					28.0				28.0				4.0
4.5	45.0	44.0	36.0					28.0	24.5			28.0				4.5
5.0	44.0	41.5	34.0	28.0				28.0	24.5			28.0	24.5			5.0
5.5	38.0	37.5	32.0	28.0				28.0	24.0	18.8		28.0	24.5			5.5
6.0	34.0	33.5	30.5	27.0	20.0			28.0	23.0	18.2		28.0	24.5			6.0
6.5	31.5	30.0	27.4	26.0	20.0			28.0	22.0	17.5		28.0	24.0	16.6		6.5
7.0	29.0	27.1	24.8	23.9	20.0			28.0	21.5	17.0	11.8	25.9	23.5	16.6		7.0
7.5	26.0	24.7	22.6	21.9	19.5	14.5		26.1	20.5	16.5	11.8	23.8	22.5	16.3		7.5
8.0	23.4	22.5	20.7	20.2	18.5	14.5		24.0	20.0	15.5	11.8	21.9	20.9	15.8	10.8	8.0
9.0	19.2	18.5	17.5	17.3	16.8	13.7	10.0	20.5	18.5	14.0	11.5	18.8	18.1	14.8	10.5	9.0
10.0		15.4	15.0	15.0	14.7	13.0	10.0	17.3	17.0	13.0	10.8	16.3	15.9	13.8	10.2	10.0
11.0		13.0	12.7	13.1	13.0	12.2	9.8	14.9	15.3	12.0	10.0	14.2	14.0	12.7	9.8	11.0
12.0		11.1	10.8	11.5	11.5	11.3	9.5	13.0	13.5	11.1	9.5	12.3	12.5	11.7	9.4	12.0
14.0			7.9	8.9	9.2	9.1	8.5	10.0	10.6	9.6	8.2	9.4	10.0	9.9	8.5	14.0
16.0			5.9	6.9	7.4	7.5	7.4	7.4	8.5	8.4	7.2	7.3	7.9	8.2	7.6	16.0
18.0			4.2	5.4	5.9	6.2	6.2		6.9	7.2	6.4	5.8	6.4	6.7	6.6	18.0
20.0				4.2	4.7	5.1	5.2		5.7	6.0	5.8	4.2	5.1	5.5	5.7	20.0
22.0				3.2	3.8	4.2	4.3		4.2	5.0	5.2		4.2	4.5	4.8	22.0
24.0				2.2	3.0	3.4	3.6			4.2	4.4		3.4	3.7	4.0	24.0
26.0					2.3	2.7	3.0			3.5	3.7		2.4	3.1	3.3	26.0
28.0					1.7	2.1	2.4			2.6	3.2			2.5	2.8	28.0
30.0					1.2	1.7	1.9				2.7			2.0	2.3	30.0
32.0						1.2	1.5				2.3			1.4	1.8	32.0
34.0						0.8	1.1				1.6				1.5	34.0
36.0							0.8								1.1	36.0
38.0															0.7	38.0
	12	10	8	6	5	3	3	6	6	4	3	6	6	4	3	
2#	0	50	100	100	100	100	100	0	0	0	0	50	50	50	50	2#
3#	0	0	0	25	50	75	100	25	50	75	100	25	50	75	100	3#
4#	0	0	0	25	50	75	100	25	50	75	100	25	50	75	100	4#
5#	0	0	0	25	50	75	100	25	50	75	100	25	50	75	100	5#
Min	15	15	15	15	15	22	33	15	15	15	15	15	15	15	15	Min
Max	78	78	78	78	78	78	78	78	78	78	78	78	78	78	78	Max

Load chart of FJ



H Load Chart

 m	46 +9.2			46 +16			 m
	0°	15°	30°	0°	15°	30°	
11.0	5.0						11.0
12.0	4.8						12.0
14.0	4.6	3.1		2.8			14.0
16.0	4.2	3.0	2.5	2.6	1.9		16.0
18.0	3.9	2.9	2.4	2.5	1.8		18.0
20.0	3.7	2.7	2.3	2.5	1.7	1.3	20.0
22.0	3.3	2.6	2.2	2.3	1.6	1.3	22.0
24.0	2.8	2.5	2.1	2.2	1.5	1.2	24.0
26.0	2.4	2.3	1.9	2.1	1.4	1.2	26.0
28.0	2.0	2.0	1.8	2.0	1.3	1.2	28.0
30.0	1.5	1.7	1.7	1.8	1.3	1.1	30.0
32.0	1.2	1.3	1.5	1.5	1.2	1.1	32.0
34.0	0.8	1.0	1.2	1.2	1.1	1.0	34.0
36.0	0.4	0.7	0.9	1.0	1.1	1.0	36.0
38.0			0.5	0.7	1.0	0.9	38.0
40.0				0.3	0.8	0.8	40.0
42.0					0.5	0.6	42.0
44.0						0.3	44.0
 t _n	1	1	1	1	1	1	 t _n
 2#	100	100	100	100	100	100	2# 
 3#	100	100	100	100	100	100	3# 
 4#	100	100	100	100	100	100	4# 
 5#	100	100	100	100	100	100	5# 
 Min/Max	48	48	48	48	48	48	 Min/Max
 Min/Max	78	78	78	78	78	78	 Min/Max

Note-Rate load of crane:

- The rated load in the load chart is calculated complying with EN13000.
- The rated capacity in the load charts are calculated when the crane is parking on firm and level ground less than 1° gradient, and lifting the load slowly and steadily.
- The rated capacity values in the load charts are obtained when the wind speed is lower than 9.8 m/s on 75% of tipping load.
- The gray-shaded values in boom load chart are determined by boom strength, and the rest of values by stability; The load chart of FJ is determined by boom and jib strength.
- All values in the load charts are valid for 360° slewing.
- The rated load shall be no more than 5t when using boom tip sheave. If the jib unfolds, the rated lifting capacity of boom is 2t less.
- The rated capacity in the load charts include the weight of lifting hook, (main hook 0.62t, jib hook 0.1t), therefore, the actual rated capacity shall deduct the weight of lifting hook, riggings and wire rope from the rated load in the load charts.
- If the actual boom length and working radius is between two values above, the larger one is available.
- Rear counterweight: 19t.
- The largest gradient allowed for lifting is 4°; Check Operation Manual for load charts in details.



Zhejiang Sany Equipment Co.,LTD

SANY Crawler Crane Industrial Park, No. 2188 Daishan Road, Wuxing District, Huzhou City, Zhejiang Province, P. R. China Zip 313028

Consulting sanycrane@sanygroup.com (Crane BU) / crd@sany.com.cn (IHQ)

After-sales Service 0086-400 6098 318

Reminder:

Any change in the technical parameters and configuration due to product modification or upgrade may occur without prior notice.

The machine in the picture may include additional equipment. This brochure is for reference only, and goods in kind shall prevail.

Copyright at SANY. No part of this brochure may be copied or used for any purpose without written approval from SANY.

© Edited in June 2025

